

150mm Square Floor Waste Arrestor (suits 100mm pipe)



FW-150BS-304

FW-150BS-316

- Hinged grate
- Heel proof
- Fixed strainer with 4mm holes
- Removable basket with 4mm holes
- 304 or 316 grade stainless steel
- Suits 100mm DWV, HDPE pipe



FW-BASKET-100

Top

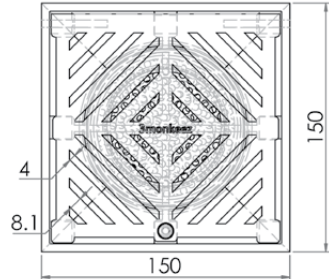

Front

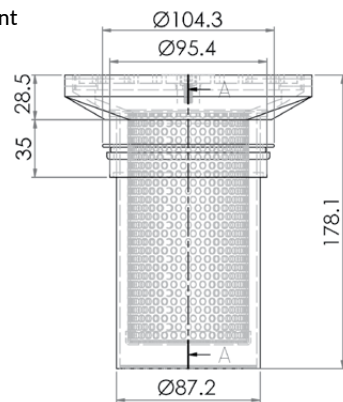

Cross Section

